

# Hochiki ESP Sensor & Base Range Installation Instructions



**Products Covered: ALG-E, ALG-E(NP), ALG-EN / AIE-E, AIE-E(NP) / ACA-E / ACB-E, ACB-EW / YBN-R/3**

## Introduction

The analogue Sensors listed above can all use a Common Mounting Base (YBN-R/3), which is electronics free, the Base Sounder (YBO-BS), the Base Sounder Beacon (YBO-BSB) and the Short Circuit Isolator Base (YBO-R/SCI) (except the ACB-EW, which utilises flying leads). Please note that a sensor suffixed by NP is a non-pulsing type and the LED's will not flash when polled, but the LED's will illuminate when the sensor is in a fire condition. The ACA-E, ACB-E, ALG-EN and ACB-EW polling LED can be turned off at the Control Panel (Control Panel compatibility needs to be checked to verify if this facility is supported). Follow the guidelines below before installation and maintenance. Hochiki cannot guarantee a sensor's performance if these guidelines are not followed.

## Caution

Hochiki ESP range sensors cannot be used to prevent fire itself, they are only intended to detect a certain characteristic of fire. The ACA-E (Heat mode only), ACB-E and ACB-EW sensors are used to detect conditions and changes in temperature and cannot detect smoke and other phenomena. When installing the sensor, check that the location of each one has been planned according to appropriate fire regulations or recommendations. Please note that the ACA-E Multi-Sensor default mode is optical/heat, if this sensor is to be programmed to change modes i.e.: - optical to heat then the ACA-E should be spaced as a standard Heat Sensor.

The sensor and base combination should be installed to the following guidelines:

- Ensure the Sensor and Base are installed in accordance with Local Standards or Regulations.
- Sensor and Base combinations should only be installed where ambient temperatures are between -10°C to +50°C and where the condensation and moisture levels are between 10% to 95% RH – Non-condensing (at 40°C).
- Only install in suitable environments, the following should be avoided.
  - Situations in which condensation exists.
  - Situations in which corrosive gases exist.
  - Situations in which dust or steam exists.
  - Situations in which obstacles exist, which could impede airflow to the sensor.
  - Hazardous areas.
- Do not use a high voltage tester on any Sensor or any Base with electronics (YBO-BS, YBO-BSB & YBO-R/SCI).

Certain actions can cause permanent damage to the sensor. If the sensor is subjected to any of the following it should not be used:

- Disassembly and re-assembly.
- Impact or shock.
- Touching the thermistor (ACB-E, ACB-EW) Heat sensors and ACA-E Multi-Sensor only).

If damage is suspected after a fire has occurred, the sensor should be replaced. After installation, all sensors on the fire alarm system should be tested to confirm correct operation. Installation and maintenance should only be carried out by suitably trained engineers. Sensor operation should not be tested with a naked flame or open fire. Operation should only be checked by equipment that is capable of exceeding the required detection threshold.

The sensor must be subject to periodic maintenance during regular service visits. This period should be outlined in the appropriate standards or recommendations. If there are no such standards existing, Hochiki recommend that the minimum period of maintenance should be 1 year and that the following should be taken into account:

- A regular operation test should be performed.
- A visual check for staining and mechanical damage should be made.

A dust cover is included with the sensor to prevent contamination during installation. **The dust cover must be removed for the sensor to operate.**

## Setting the Address

Each sensor must have its address set before system operation. Using the installation plan that shows the proper location for each sensor, find the address for the sensor to be installed. Check that the address and location on the plan match correctly. Address is any number from 1 to 127. For address setting, use the address programmer and write the number on the label of the sensor after setting. When address changing, renew the number on the label. See the instruction of the appropriate address programmer TCH-B100 about detail of setting method. Note that to program the ACB-EW with the TCH-B100 address programmer, a programming lead (PL-2) must be used (jack plug to croc-clips).

## Wiring and Head Locking Mechanism

The bases should be wired as shown in figure 1 below. Note that the ACB-EW features flying leads for connection to the loop and is supplied with its own fixing base. The ESP range of Sensors can also be locked onto the relevant bases by removing a plastic lug on the underside of the sensor, please refer to figure 1. The Sensor can then only be removed by using a special removal tool, which is available from Hochiki Europe (UK) Ltd.

Remove tab carefully using a pair of pliers

Fig.1

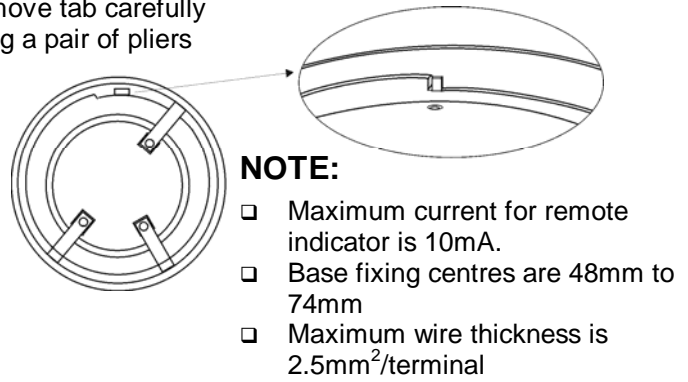

A: Loop (+) B: Loop (-) C: Cable Screen

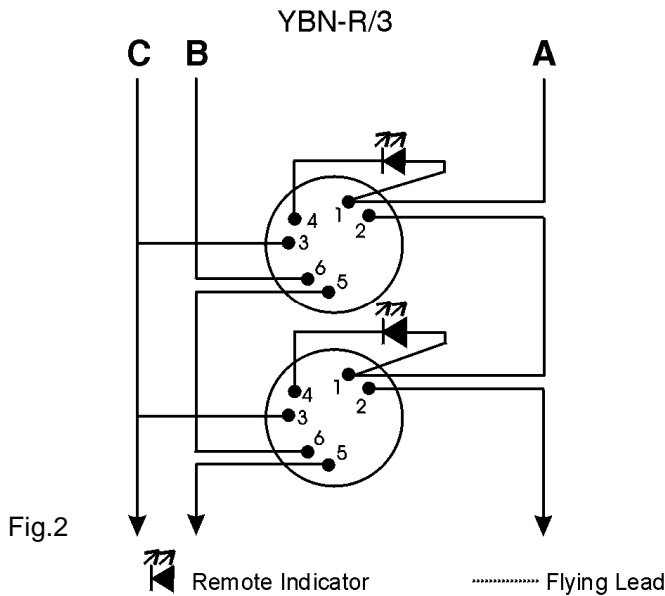
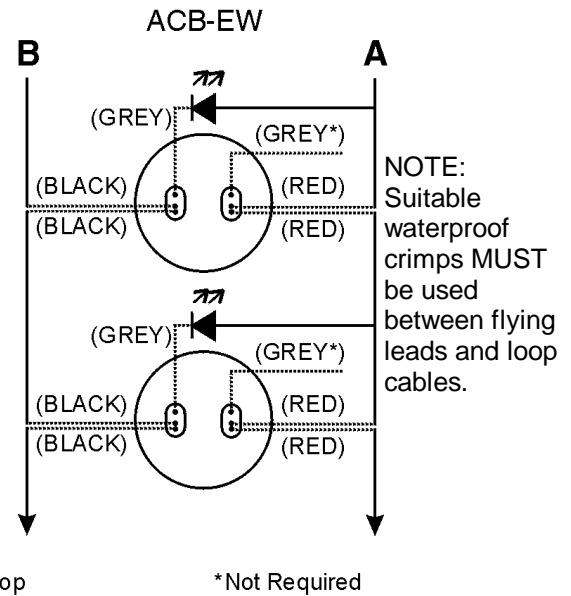
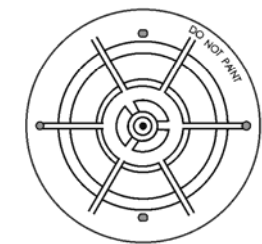

Fig.2



## ESP RANGE SENSORS



ANALOGUE HEAT SENSOR  
ACB-E / ACB-EW

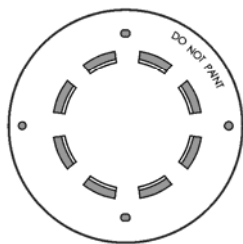

ANALOGUE IONISATION  
SMOKE SENSOR - AIE-E

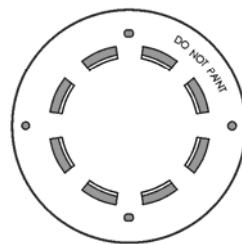

ANALOGUE PHOTO-ELECTRIC  
SMOKE SENSOR - ALG-E/ALG-EN

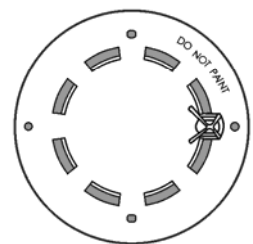
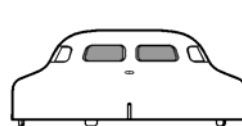

ANALOGUE MULTI-SENSOR  
ACA-E

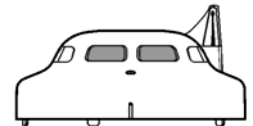

**Hochiki Europe (UK) Ltd**  
 Grosvenor Road, Gillingham Business Park,  
 Gillingham, Kent, ME8 0SA, England  
 Telephone: +44(0)1634 260133 Facsimile: +44(0)1634 260132  
 Email: sales@hochikieurope.com  
 Web: www.hochikieurope.com

Hochiki Europe (UK) Ltd. reserves the right to alter the specification of its products from time to time without notice. Although every effort has been made to ensure the accuracy of the information contained within this document it is not warranted or represented by Hochiki Europe (UK) Ltd. to be a complete and up-to-date description. Please check our web site for the latest version of this document.